

God made Himself known to us in Jesus.

Match the people who are the same.

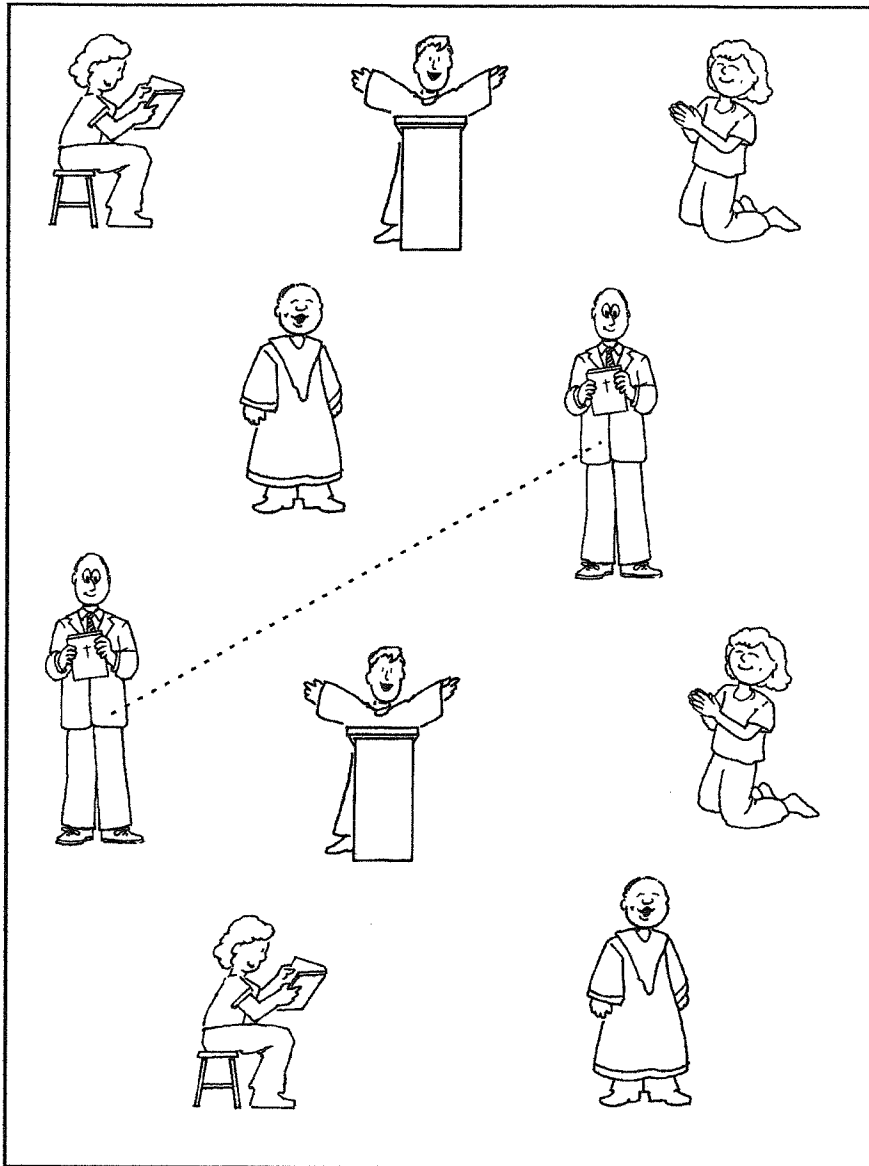

Children's Worship Bulletin™

Ages 3+

1 Corinthians 1:3-9

Jesus Keeps You Strong

Be friends with Jesus.

Help the child find her way to Jesus.
1 2 3 4 5 6 7 8 9 10

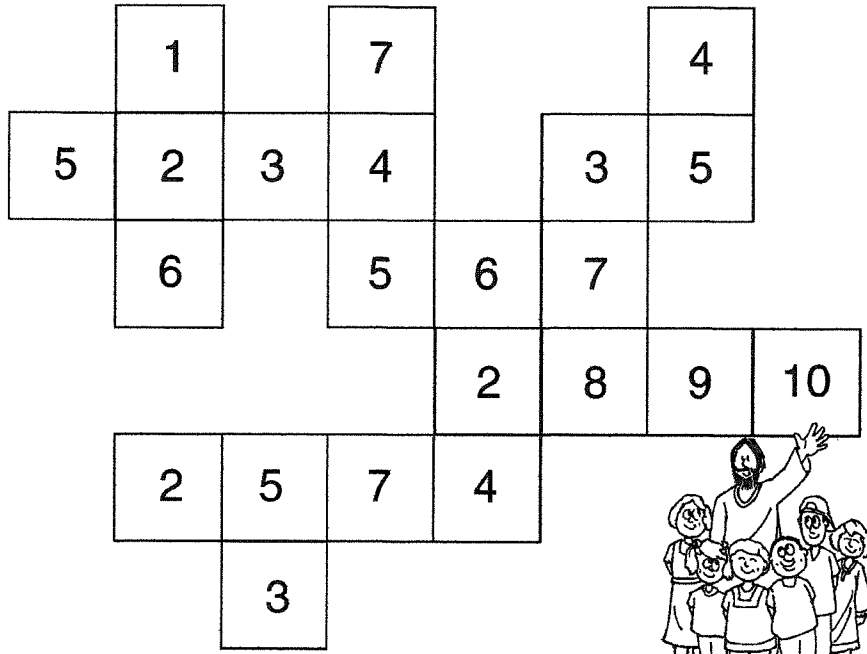

God will keep you ...

Use the code to fill in the letters.

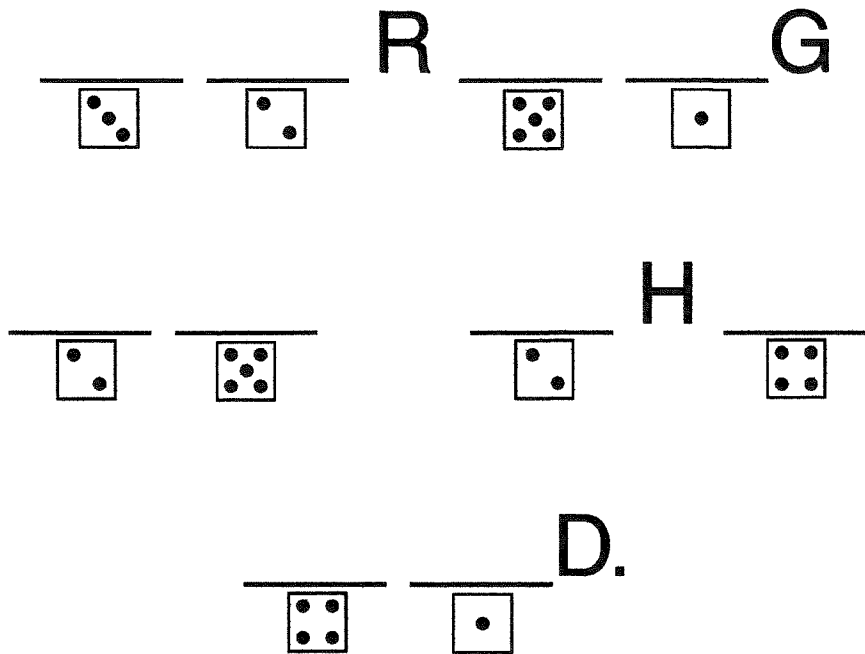
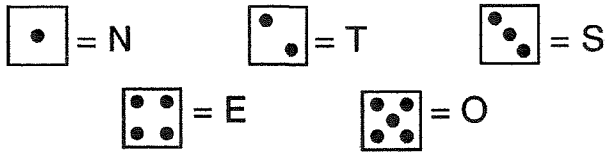

In Jesus our lives are better in every way.

Circle and find these objects.

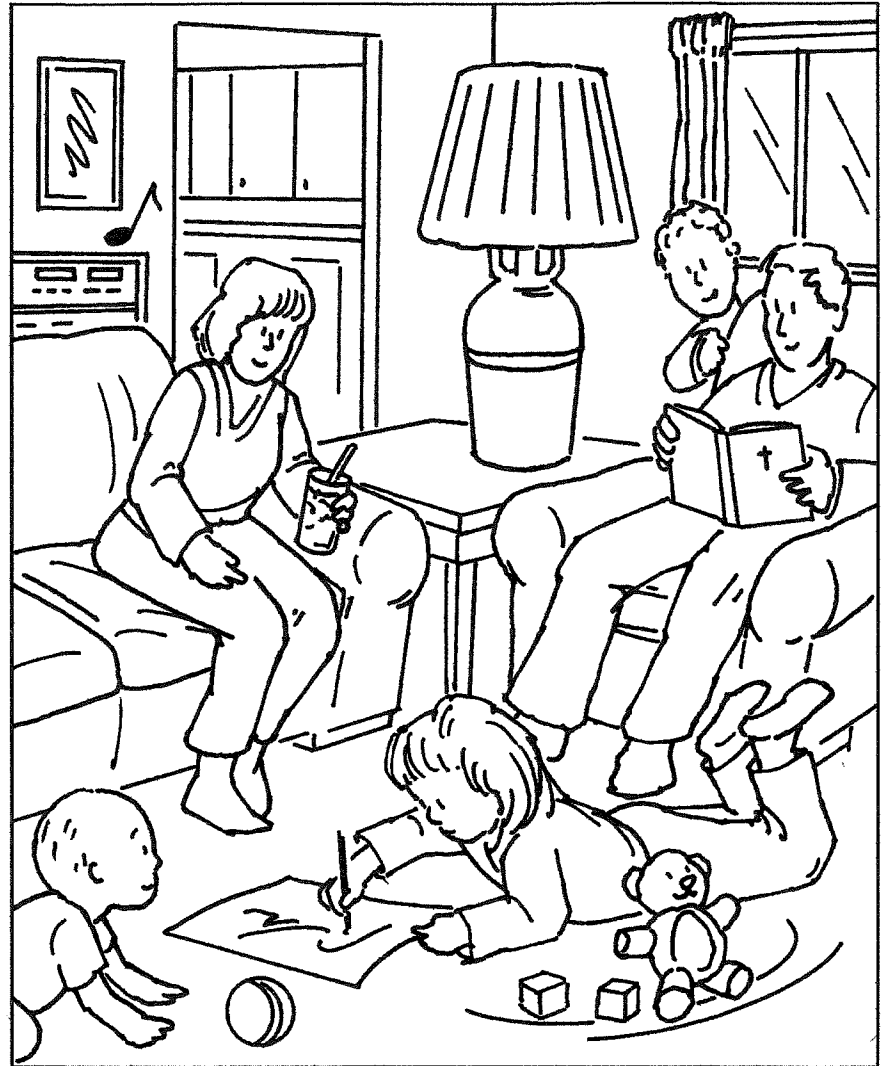

God enabled the Corinthian believers to be blameless before Him.

Supply the missing letters in the verse, then rearrange them to spell the missing word ...

Paul told them ...

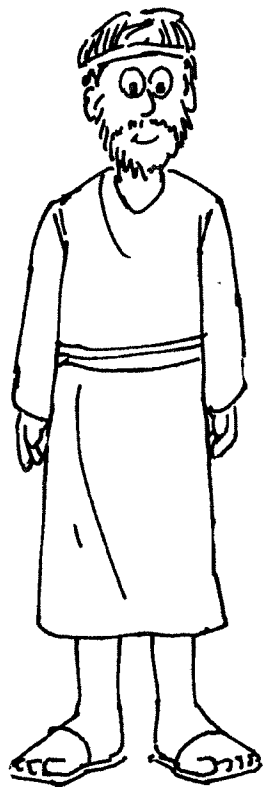

“You do not lack
 any spiritual gift
 as you eagerly
 wait for our Lord.”

That was because of God’s

□ □ □ □ □ .

Paul reassured the Corinthians that God’s power would keep them spiritually strong.

Find the right path through the maze. Write the letters in order in the blanks to make words. The number of letters in each word is given.

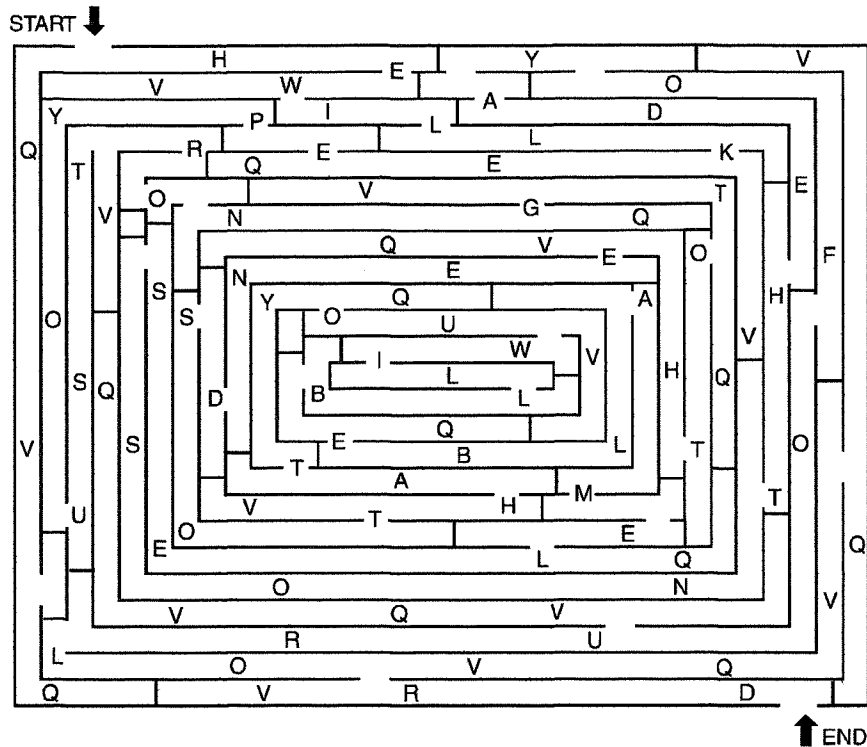

2	4	4	3	6	
2	3	3	2	4	3
4	2	9	2	3	
3	2	3	4		